



PRIMA COLLECTION

2026



INDICE

INDEX

POSATE / CUTLERY

Bell.....	15
Country.....	30
Daisy.....	28
Derby.....	11
Dinner.....	14
Dover.....	19
Drop.....	36
Drop Satin.....	38
Duke Satin.....	32
Easy.....	7
Eat.....	20
Flavia.....	10
Galles.....	16
Lunch.....	4
Marina.....	12
Marina Vibrato.....	8
Milano.....	17
Monaco.....	13
Nice.....	3
Ponza.....	24
Princess.....	34
Sea.....	6
Venezia.....	18
Versilia.....	9
Villa.....	22
Villa Satin.....	23
Accessori/Accessories.....	41
Confezioni posate / Cutlery packaging.....	27
Prima set oliere / Cruet set	42
Set coltelli / Knives set.....	40

COTTURA / COOKWARE

Comfort.....	52
Cook-it.....	61
Ecoline.....	46
First.....	54
First pent. pressione / Pressure cooker.....	55
Inox Plus.....	50
Pop	58
Pop Extra.....	60
Portofino.....	65
Smart set padelle / Frying pan set.....	64
Tender Alu Easy	56
X-Black	62

GASTRONORM

GN-P.....	67
-----------	----

UTENSILI DA CUCINA / KITCHEN TOOLS

Gadget Fast.....	71
Gadget FPR.....	74
Smart.....	78



NICE

004

18/0





mm 1,5



SOLO VENDITA MASTER
ONLY MASTER SELLING



Chiave
(master pcs 24)

		cod. chiave	cm cutlery
x3		AW301	19,0
x3		AW302	19,0
x2		AW2L3	21,5
x4		AW407	14,0
x4		AW417	14,0

LUNCH

296

18/0

UDV 12 pz

mm 1,8

Confezione 12 pz / 12 pcs box

cod.



00001



00002



000L3



000F3



000F7



00007



00017





SEA R02

18/0
UDV 120 pz
mm 1,5





Set posate / Cutlery set

cod.	set
0E2SN	16 pcs
0E291	24 pcs

**SOLO VENDITA MASTER
ONLY MASTER SELLING**

Master pcs 120

cod. master

	0M001
	0M002
	0M0L3
	0M007







**SOLO VENDITA MASTER
ONLY MASTER SELLING**



Chiave
(master pcs 24)

cod. chiave	cm cutlery
-------------	------------

x3 	HW301	19,7
x3 	HW302	20,0
x2 	HW2L3	21,3
x6 	HW607	13,0

EASY

124

18/0

UDV 12 pz





mm 1,5



Set posate / Cutlery set

cod.	set
0E2SN	16 pcs
0E291	24 pcs





Confezione 12 pz / 12 pcs box

	cod.
	00001
	00002
	000L3
	00007
	00017

SOLO VENDITA MASTER
ONLY MASTER SELLING



Valva
(master pcs 10)





	cod. valva
x24 	0\$Q01
x24 	0\$Q02
x12 	0\$HL3*
x36 	0\$B07
x36 	0\$B17

*lamin. 3,8 mm

SOLO VENDITA MASTER
ONLY MASTER SELLING



Chiave
(master pcs 24)

	cod. chiave	cm cutlery
x3 	EW301	19,0
x3 	EW302	19,0
x2 	EW2L3	20,9
x6 	EW607	13,7
x6 	EW417	13,6

MARINA VIBRATO

117

18/0

UDV 240 pz

mm 1,8

Set posate / Cutlery set

cod. set







1E2SN 16 pcs

1E291 24 pcs

**SOLO VENDITA MASTER
ONLY MASTER SELLING**

Master pcs 240

cod.
master







	1M001
	1M002
	1M0L3
	1M004
	1M005
	1M007
	1M008



**SOLO VENDITA MASTER
ONLY MASTER SELLING**



Chiave
(master pcs 24)

	cod. chiave	cm cutlery
x3	 KW301	19,7
x3	 KW302	20,0
x2	 KW2L3	21,0
x3	 KW304	18,5
x3	 KW305	18,7
x6	 KW607	13,0
x6	 KW608	11,2

VERSILIA

102

18/0

UDV 12 pz

mm 1,5

Set posate / Cutlery set

cod. set

0E2SN 16 pcs

0E291 24 pcs

Confezione 12 pz / 12 pcs box

cod.



00001



00002



000L3



00007





SOLO VENDITA MASTER
ONLY MASTER SELLING



Chiave
(master pcs 24)

cod. cm
chiave cutlery

x3  **EW301** 19,7

x3  **EW302** 19,2

x2  **EW2L3** 22,0

x6  **EW607** 12,5

FLAVIA

109

18/0

UDV 12 pz

mm 1,5

Set posate / Cutlery set

cod. set

0E2SN 16 pcs

0E291 24 pcs

Confezione 12 pz / 12 pcs box

cod.

 **00001**

 **00002**

 **000L3**

 **00007**



SOLO VENDITA MASTER
ONLY MASTER SELLING



Chiave
(master pcs 24)

cod. cm
chiave cutlery

x3  **EW301** 19,5

x3  **EW302** 19,5

x2  **EW2L3** 22,2

x6  **EW607** 12,5

DERBY R03

18/0

UDV 120 pz

mm 2,0

Set posate / Cutlery set

cod. set









0E2SN 16 pcs

0E291 24 pcs

**SOLO VENDITA MASTER
ONLY MASTER SELLING**

Master pcs 120

**cod.
master**

	0M001
	0M002
	0M0L3
	0M0F3
	0M004
	0M005
	0M0L6
	0M007
	0M008











**SOLO VENDITA MASTER
ONLY MASTER SELLING**



Chiave

(master pcs 24)

cod. chiave cm cutlery

x3		FW301	19,6
x3		FW302	19,6
x2		FW2L3	22,0
x3		FW304	17,8
x3		FW305	17,7
x2		FW2L6	19,4
x6		FW607	14,1
x6		FW608	11,5

MARINA

117

18/0

UDV 240 pz

mm 1,8

Set posate / Cutlery set

cod. set









0E2SN 16 pcs

0E291 24 pcs

**SOLO VENDITA MASTER
ONLY MASTER SELLING**

Master pcs 240

**cod.
master**

	0M001
	0M002
	0M0L3
	0M004
	0M005
	0M007
	0M008
	0M017











**SOLO VENDITA MASTER
ONLY MASTER SELLING**



Chiave
(master pcs 24)

**cod.
chiave** cm
cutlery

x3		HW301 19,7
x3		HW302 20,0
x2		HW2L3 21,0
x3		HW304 18,5
x3		HW305 18,7
x6		HW607 13,0
x6		HW608 11,2
x6		HW617 14,7

MONACO

174

18/0

UDV 120 pz

mm 1,8

Set posate / Cutlery set

cod. set











0E2SN 16 pcs

0E291 24 pcs

**SOLO VENDITA MASTER
ONLY MASTER SELLING**

Master pcs 120













	cod. master
	0M001
	0M002
	0M0L3
	0M004
	0M005
	0M0L6
	0M007
	0M008
	0M017
	0M036

**SOLO VENDITA MASTER
ONLY MASTER SELLING**



Chiave
(master pcs 24)

	cod. chiave	cm cutlery
x3 	GW301	19,6
x3 	GW302	19,6
x2 	GW2L3	20,8
x3 	GW304	18,5
x3 	GW305	18,5
x2 	GW2L6	19,7
x6 	GW607	13,0
x6 	GW608	11,3
x6 	GW617	15,0
x6 	GW636	21,0

DINNER R04

18/0
UDV 120 pz
mm 2,0

Set posate / Cutlery set

cod. set





0E2SN 16 pcs

0E291 24 pcs

**SOLO VENDITA MASTER
ONLY MASTER SELLING**

Master pcs 120

**cod.
master**

	0M001
	0M002
	0M0L3
	0M0F3
	0M0F7
	0M007







**SOLO VENDITA MASTER
ONLY MASTER SELLING**



Chiave
(master pcs 24)

**cod.
chiave** cm
cutlery

x3		HW301 20,0
x3		HW302 20,0
x2		HW2L3 22,0
x6		HW607 14,2

BELL 144

18/0

UDV 120 pz

mm 1,5

Set posate / Cutlery set

cod. set

0E2SN 16 pcs

0E291 24 pcs

**SOLO VENDITA MASTER
ONLY MASTER SELLING**

Master pcs 120

**cod.
master**

 **0M001**

 **0M002**

 **0M0L3**

 **0M007**





**SOLO VENDITA MASTER
ONLY MASTER SELLING**





Chiave
(master pcs 24)

cod. chiave cm cutlery

x3  **FW301** 19,6

x3  **FW302** 19,5

x2  **FW2L3** 21,3

x6  **FW607** 14,0

GALLES

089

18/10

UDV 12 pz









mm 1,8







Set posate / Cutlery set

cod.	set
XE2SN	16 pcs
XE291	24 pcs

Confezione 12 pz / 12 pcs box

	cod.
	X0001
	X0002
	X00L3
	X00F3
	X0005
	X00L6
	X0007
	X0008
	X0017

Sfuso / Single pieces

	cod.	cm cutlery
	X0010	26,8
	X0011	21,8
	X0012	21,6
	X0020	23,4

SOLO VENDITA MASTER
ONLY MASTER SELLING



Chiave
(master pcs 24)

	cod. chiave	cm cutlery
x3	GW301	21,0
x3	GW302	21,0
x2	GW2L3	22,0
x3	GW305	17,6
x2	GW2L6	19,6
x6	GW607	15,2
x6	GW608	11,6
x6	GW617	15,2

MILANO

R10

18/10

UDV 120 pz

mm 2,2

Set posate / Cutlery set

cod. set





0E2SN 16 pcs

0E291 24 pcs

**SOLO VENDITA MASTER
ONLY MASTER SELLING**

Master pcs 120

**cod.
master**





	0M001
	0M002
	0M0L3
	0M007



**SOLO VENDITA MASTER
ONLY MASTER SELLING**



Chiave
(master pcs 24)

	cod. chiave	cm cutlery
x3 	CW301	19,5
x3 	CW302	19,5
x2 	CW2L3	21,5
x6 	CW607	14,0

VENEZIA

R08

18/10

UDV 120 pz

mm 2,2

Set posate / Cutlery set

cod. set

0E2SN 16 pcs

0E291 24 pcs

**SOLO VENDITA MASTER
ONLY MASTER SELLING**

Master pcs 120

**cod.
master**

 **0M001**

 **0M002**

 **0M0L3**

 **0M007**



**SOLO VENDITA MASTER
ONLY MASTER SELLING**



Chiave
(master pcs 24)

**cod. cm
chiave cutlery**

x3  **CW301** 19,5

x3  **CW302** 19,5

x2  **CW2L3** 21,5

x6  **CW607** 13,3

DOVER R11

18/0

UDV 120 pz

mm 2,5

Set posate / Cutlery set

cod. set





0E0SN 16 pcs

0E091 24 pcs

**SOLO VENDITA MASTER
ONLY MASTER SELLING**

Master pcs 120

**cod.
master**











	0M001
	0M002
	0M003
	0M0F3
	0M067
	0M004
	0M005
	0M006
	0M007
	0M008
	0M017
	0M036

**SOLO VENDITA MASTER
ONLY MASTER SELLING**



Chiave
(master pcs 24)

cod. chiave cm cutlery

x3		BW301 20,2
x3		BW302 20,5
x2		BW203 23,5
x2		BW267 22,5
x3		BW304 17,8
x3		BW305 17,7
x2		BW206 21,5
x6		BW607 14,0
x6		BW608 12,2
x6		BW617 15,1
x6		BW636 21,0

EAT 257









18/10
UDV 12 pz
mm 1,8



Set posate / Cutlery set

cod.	set
0E0SN	16 pcs
0E091	24 pcs







Confezione 12 pz / 12 pcs box

	cod.
	00001
	00002
	00003
	00007
	00008
	00017
	00067
	00051

SOLO VENDITA MASTER
ONLY MASTER SELLING









Valva
(master pcs 10)

		cod. valva
x12		0\$H01
x12		0\$H02
x6		0\$603
x20		0\$U07
x18		0\$\$17
x6		0\$651

SOLO VENDITA MASTER
ONLY MASTER SELLING



Chiave
(master pcs 24)

		cod. chiave	cm cutlery
x3		LW301	20,1
x3		LW302	19,9
x2		LW203	21,8
x6		LW607	14,2
x6		LW608	11,5
x6		LW617	15,5



VILLA 255













18/10
UDV 12 pz
mm 2,5

Set posate / Cutlery set

cod.	set
0E0SN	16 pcs
0E091	24 pcs

Confezione 12 pz / 12 pcs box













	cod.
	00001
	00002
	00003
	000F3
	000F7
	00004
	00005
	00006
	000F6
	00007
	00008
	00017
	00029

SOLO VENDITA MASTER
ONLY MASTER SELLING



Chiave
(master pcs 24)

	cod. chiave	cm cutlery
x3 	CW301	20,9
x3 	CW302	20,8
x2 	CW203	23,0
x3 	CW304	18,0
x3 	CW305	18,0
x2 	CW206	21,0
x6 	CW607	14,5
x6 	CW608	11,1
x6 	CW617	15,6
x3 	CW329	20,0

VILLA SATIN

255

18/10

UDV 12 pz

mm 2,5



Set posate / Cutlery set











cod. set

UE0SN 16 pcs

UE091 24 pcs

Confezione 12 pz / 12 pcs box

cod.

	U0001
	U0002
	U0003
	U0004
	U0005
	U0006
	U0007
	U0008
	U0017
	U0029

PONZA

256

18/10

UDV 12 pz

mm 2,5



Set posate / Cutlery set

cod. set

0E0SN 16 pcs

0E091 24 pcs

Confezione 12 pz / 12 pcs box

cod.

 **00001**

 **00002**

 **00003**

 **00004**

 **00005**

 **00006**

 **00007**

 **00008**

 **00017**

 **00029**

Sfuso / Single pieces

cod.

 **00010**

 **00011**

 **00012**

 **00013**

SOLO VENDITA MASTER
ONLY MASTER SELLING



Chiave
(master pcs 24)

cod. cm
chiave cutlery

x3  **GW301** 20,3

x3  **GW302** 20,1

x2  **GW203** 22,8

x3  **GW304** 18,0

x3  **GW305** 18,0

x2  **GW206** 21,0

x6  **GW607** 14,0

x6  **GW608** 11,7

x6  **GW617** 15,4

x3  **GW329** 20,5



CONFEZIONI
PACKAGING

CONFEZIONI POSATE CUTLERY PACKAGING

Ecobox 16/24 pz
Ecobox 16/24 pcs
cod. 92032020



Confezione 12 pz
Box 12 pcs

cod.	descriz.
90515000	confezione grande <i>large box</i>
90515001	confezione piccola <i>small box</i>



DAISY

2G_07091

18/0 + ABS
SET 24 PCS



cod. colour

A 
BLACK

B 
WHITE

C 
BLUE

D 
SAND

E 
GREEN

F 
RED





COUNTRY

2F_07091

18/0 + ABS
SET 24 PCS



cod. colour

A



WOOD

B



BLACK

C



GREY

D



GREEN





DUKE SATIN

2K_U7091

18/0

SET 24 PCS

mm 3,0



cod. colour

O



STEEL

R



SUN

S



AMBER

T



CARBON



Confezione 12 pz
12 pcs box

cod. colour



2KRU0001



2KRU0002



2KRU0003



2KRU0007



SUN



2KSU0001



2KSU0002



2KSU0003



2KSU0007



AMBER



2KTU0001



2KTU0002



2KTU0003



2KTU0007



CARBON



PRINCESS

2C_07091

18/0

SET 24 PCS

mm 3,0



cod. colour

0



STEEL

R



SUN

S



AMBER

T



CARBON

U*



RAINBOW

* In esaurimento / Discontinued



Confezione 12 pz
12 pcs box

cod. colour

2CR00001



2CR00002



2CR00003



2CR00007



2CS00001



2CS00002



2CS00003



2CS00007



2CT00001



2CT00002



2CT00003



2CT00007



CARBON



DROP

28500091



18/0

SET 24 PCS

mm 2,0

design Marcello Ziliani





DROP SATIN

28_U0091



18/0

SET 24 PCS

mm 2,0

design Marcello Ziliani

cod. colour

5



STEEL

R



SUN

T



CARBON





SET COLTELLI

KNIVES SET

Coltello pizza (cm 20,5)

Pizza knife

cod. 74600...



cod. descriz.

P51 scatola bianca 12 pz / 12 pcs set white box

651 blister 6 pz / blister 6 pcs



Coltello tavola (cm 21,7)

Table knife

cod. 74600...

cod. descriz.

PEK scatola bianca 12 pz / 12 pcs set white box

6EK blister 6 pz / blister 6 pcs



Coltello bistecca (cm 22,2)

Steak knife

cod. 74600...

cod. descriz.

PEU scatola bianca 12 pz / 12 pcs set white box

6EU blister 6 pz / blister 6 pcs



Coltello bistecca punta tonda (cm 22,2)

Steak knife rounded tip

cod. 74600...

cod. descriz.

PFU scatola bianca 12 pz / 12 pcs set white box

6FU blister 6 pz / blister 6 pcs



Coltello bistecca con manico effetto legno (cm 22,2)

Steak knife with wooden handle effect

cod. 7460L...

cod.	descriz.
PEU	scatola bianca 12 pz / 12 pcs set white box
6EU	blister 6 pz / blister 6 pcs



Coltello bistecca punta tonda con manico effetto legno (cm 22,2)

Steak knife rounded tip with wooden handle effect

cod. 7460L...

cod.	descriz.
PFU	scatola bianca 12 pz / 12 pcs set white box
6FU	blister 6 pz / blister 6 pcs



ACCESSORI ACCESSORIES

Forbice da cucina

Kitchen scissor

cod. 58174620



Cavatappi

Corkscrew

cod. 50916200



Cavatappi professionale

Professional corkscrew

cod. 58174300



OLIERE PRIMA

5717

18/0 + vetro/glass

Sistema salvagoccia

Non-leaking system

Articoli venduti in scatola litografata

Articles are packed in lithographed box



Set oliera 5 posti / 5 pcs cruet set

cod. 57175205

ml cm

175 / 35 14x11x20



Set sale, pepe e stuzzicadenti / Salt, pepper and toothpick set

cod. 57177303

ml cm

35 10x8,3x11,5



Formaggera / Cheese bowl

cod. 57173000

ml cm

200 11x10x12,5



RICAMBI / SPARE PARTS

cod. 97200151 vetro per olio e aceto / oil and vinegar glass

cod. 97200152 vetro per sale e pepe / salt and pepper glass

cod. 97200153 vetro per stuzzicadenti / toothpick glass

cod. 97200150 vetro per formaggera / cheese bowl glass

cod. 97200154 tappo per olio / cup for oil and vinegar glass

cod. 97200155 tappo per sale e pepe / salt and pepper glass



COTTURA
COOKWARE

INOX
18/0

ECOLINE R500



MANICO IN ACCIAIO

STAINLESS STEEL HANDLE



INDUCTION

NICKEL
FREE



INOX
18/0

INOX PLUS R600



MANICO IN ACCIAIO CON FONDO
TERMODIFFUSORE

STAINLESS STEEL HANDLE WITH
THERMAL DIFFUSION BOTTOM



INDUCTION

NICKEL
FREE



INOX
18/0

COMFORT R650



MANICO IN BACHELITE CON
FONDO TERMODIFFUSORE

BAKELITE HANDLE WITH
THERMAL-DIFFUSION BOTTOM



INDUCTION

NICKEL
FREE



PRIMA COLLECTION

**LE SERIE DI
PENTOLAME
IN ACCIAIO
MADE IN
ITALY**

**MADE IN
ITALY
STAINLESS
STEEL
COOKWARE**

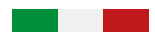

*Nickel Free
family*

1. Tutti gli articoli sono prodotti in Italia.
2. Tre serie complete:
ECOLINE: il miglior prezzo.
COMFORT: serie elegante con manici in bachelite.
INOX PLUS: ottimo rapporto qualità-prezzo.
3. Tutti gli articoli sono prodotti con acciai certificati e idonei al contatto alimentare secondo decreto legislativo DL 108 dt 25.01.92 e Dir. CEE 1935/2004 e 89/109.
4. Adatta a tutti i tipi di cucina, induzione compresa.
5. Bordo rinforzato.
6. Le maniglie e i manici sono ergonomici e in bachelite anticalore.
7. Packaging informativo dedicato.
8. Nickel Free.

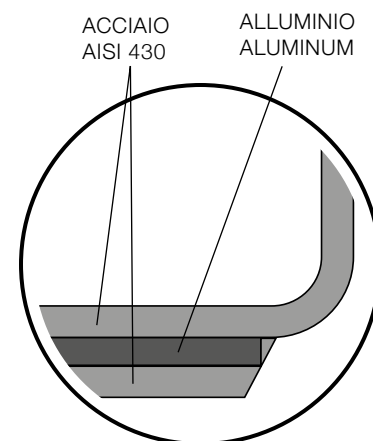

Fondo termodiffusore
*Thermal diffusion
 bottom*

1. 100% Made in Italy.
2. Three complete series.
ECOLINE: best value for money of the series.
COMFORT: Elegance series with Bakelite handles.
INOX PLUS: excellent price-quality ratio.
3. All stainless steel used in mass production is in conformity with DL 108 dated 25.01.92 & CEE 1935/2004 and 89/109 law.
4. Suitable for all kind of cooktops, including induction.
5. Reinforced edge.
6. Bakelite ergonomic handles and knobs, made to avoid heat contact.
7. Nice and dedicated packaging.
8. Nickel Free.



Maniglia in bachelite
Bakelite handles



Bordo rinforzato
Reinforced edge

ECOLINE R500

18/0

Made in Italy 

NICKEL
FREE



INDUZIONE
INDUCTION



GAS
GAS



CERAMICO
CERAMIC



ALOGENO
HALOGEN



ELETTRICO
ELECTRIC

Pentola / Pot cod. R50003..

Ø cm	h cm	Lt	Master	cm Master	kg Master
16	12	2,1	6	30x20x46	2,76
18	13	2,8	6	31x33,5x45	3,23
20	14,5	3,8	6	31x34x46	2,76
22	14,7	5	4	33x32,5x44	2,86
24	17,1	6,5	4	38x30x55	3,28
26	17,3	8,5	4	37x29x57	3,81
28	18	10,5	2	37x29x57	2,96



Casseruola / Casserole cod. R50005..

Ø cm	h cm	Lt	Master	cm Master	kg Master
16	7,5	1,3	6	24x34x23	2,53
18	8	1,8	6	24x34x23	2,54
20	9,4	2,4	6	20x30x46	2,85
22	10,5	3,5	4	46x30x18	2,40
24	11,4	4,8	4	33x30x34	2,70
26	13	5,4	4	33x30x33	2,95
28	14	8	4	37x29x57	4,06



Tegame / Roasting pan cod. R50023..

Ø cm	h cm	Lt	Master	cm Master	kg Master
24	4,5	2	6	24x34x23	3,28
28	5	3,2	6	32x32x30	3,76



Cuoci asparagi / *Asparagus pot*

cod. R5000816

Ø cm	h cm	Lt
16	20,5	4



Casseruola ovale con coperchio / *Oval casserole with lid*

cod. R50016..

cm	h cm	Lt
28	9,5	3,6
32	11	5,8



Colabrodo / *Colander*

cod. R50067..

cm
14
16



Teglia rettangolare / *Rectangular roasting pan*

cod. R50004..

cm	h cm	Lt
25x18	5	2
30x22	5,5	3,4
35x26	6	5
40x28	6,2	6,5
45x32	7,9	10



Coperchio per teglia rettangolare / *Lid for rectangular roasting pan*

cod. R50028..

cm
25x18
30x22
35x26
40x28



Bollilatte / *Milkpot*

cod. R5006012

Ø cm	h cm	Lt	Master	cm Master	kg Master
12	9	0,9	6	16x27x22	1,4



Cuoci Prima / *Cuoci Prima pot*

cod. R5087720

Ø cm	h cm	Lt
20	12,4	3,7

In esaurimento / Discontinued



Casseruola 1 manico / *Saucepan*

cod. R50006..

Ø cm	h cm	Lt	Master	cm Master	kg Master
12	5	0,5	6	24x13x28	1,01
16	7,5	1,3	6	23x23x34	1,74



Padella / *Frying pan*

cod. R50025..

Ø cm	h cm	Lt	Master	cm Master	kg Master
24	4,5	2	12	46x30x18	5,68
28	5	3,2	6	30x44,5x32,5	3,50



Cestello vapore / *Steaming basket*

cod. R5009822

Ø cm	h cm	Master	cm Master	kg Master
22	10,5	4	31x20x46	2,33



Coperchio / *Lid*

cod. R50030..

Ø cm	Master	cm Master	kg Master
16	12	26x23x33,5	1,8
18	12	26x23x36	2,11
20	12	31x20x46	2,41
22	12	31x20x46	2,94
24	12	31,5x33,5x45	3,72
26	12	31x34x45,5	4,24
28	12	31x34x45,5	5,22





INOX PLUS R600

18/0

Con fondo termodiffusore.
With thermal diffusion bottom.

Made in Italy 

NICKEL
FREE



INDUZIONE
INDUCTION



GAS
GAS



CERAMICO
CERAMIC



ALOGENO
HALOGEN



ELETTRICO
ELECTRIC

Pentola / Pot cod. R60003..

Ø cm	h cm	Lt
16	12	2,1
18	13	2,8
20	14,5	3,8
22	14,7	5
24	17,1	6,5
26	17,3	8,5
28	18	10,5



Casseruola / Casserole cod. R60005..

Ø cm	h cm	Lt
16	7,5	1,3
18	8	1,8
20	9,4	2,4
22	10,5	3,5
24	11,4	4,8
26	13	5,4
28	14	8



Tegame / Roasting pan cod. R60023..

Ø cm	h cm	Lt
24	4,5	2
28	5	3,2



Casseruola 1 manico / Saucepan cod. R60006..

Ø cm	h cm	Lt
12	5	0,5
16	7,5	1,3



Bollilatte / *Milkpot*

cod. R6006012

Ø cm	h cm	Lt
12	9	0,9



Padella / *Frying pan*

cod. R60025..

Ø cm	h cm	Lt
24	4,5	2
28	5	3,2



Cestello vapore / *Steaming basket*

cod. R5009822

Ø cm	h cm
22	10,5



Coperchio / *Lid*

cod. R50030..

Ø cm	Master	cm Master	kg Master
16	12	26x23x33,5	1,8
18	12	26x23x36	2,11
20	12	31x20x46	2,41
22	12	31x20x46	2,94
24	12	31,5x33,5x45	3,72
26	12	31x34x45,5	4,24
28	12	31x34x45,5	5,22



COMFORT R650

18/0

Con manico in bachelite e fondo termodiffusore.
With bakelite handle and thermal diffusion bottom.

Made in Italy 

NICKEL
FREE



INDUZIONE
INDUCTION



GAS
GAS



CERAMICO
CERAMIC



ALOGENO
HALOGEN



ELETTRICO
ELECTRIC

Pentola / Pot

cod. R65003..

Ø cm	h cm	Lt
16	12	2,1
18*	13	2,8
20	14,5	3,8
22	14,7	5
24	17,1	6,5
28*	18	10,5

* In esaurimento / Discontinued



Casseruola / Casserole

cod. R65005..

Ø cm	h cm	Lt
16	7,5	1,3
18	8	1,8
20	9,4	2,4
22	10,5	3,5
24	11,4	4,8
26	13	5,4
28	14	8



Tegame / Roasting pan

cod. R65023..

Ø cm	h cm	Lt
24	4,5	2
28	5	3,2



Casseruola 1 manico / Saucepan

cod. R65006..

Ø cm	h cm	Lt
12	5	0,5
16	7,5	1,3



Bollilatte / *Milkpot*
cod. R6506012

Ø cm	h cm	Lt
12	9	0,9



Padella / *Frying pan*
cod. R65025..

Ø cm	h cm	Lt
24	4,5	2
28	5	3,2



Cestello vapore / *Steaming basket*
cod. R6509822

Ø cm	h cm
22	10,5



Coperchio / *Lid*
cod. R65031..

Ø cm
16
18
20
22
24
26
28



FIRST R800

18/10

Fondo 3 strati.
3 layers bottom.

Articoli venduti in scatola litografata.
Articles are packed in lithographed box.

In esaurimento / Discontinued



INDUZIONE
INDUCTION



GAS
GAS



CERAMICO
CERAMIC



ALOGENO
HALOGEN



ELETTRICO
ELECTRIC

Pentola bassa con coperchio / *Low pot with lid*
cod. R800V3..

Ø cm	Lt
20	3,1
24	6,3
28	11



Casseruola con coperchio / *Casserole with lid*
cod. R800V1..

Ø cm	Lt
20	2,5
24	4,5



Casseruola 1 manico / *Saucepan*
cod. R8000616

Ø cm	Lt
16	1,5



Bollilatte / *Milk pot*
cod. R8006014

Ø cm	Lt
14	1,5



FIRST R800

18/0

4 Sistemi di Sicurezza.
4 Safety Systems.

INDUZIONE / INDUCTION



INDUZIONE
INDUCTION



GAS
GAS



CERAMICO
CERAMIC



ALOGENO
HALOGEN



ELETTRICO
ELECTRIC

Pentola a pressione tradizionale
Traditional pressure cooker

cod.	Lt	Ø cm
R8005103	3,5	20
R8005105	5	20
R8005107	7	20
R8005109	9	22



Set pentole a pressione Lt 5+7
Pressure cooker set Lt 5+7

cod. R8005D57

Ø cm	Lt
20	5+7



Pentola Ø cm 20 5 lt,
Pentola Ø cm 20 7 lt,
Coperchio in acciaio
inox 18/0 per pentola
a pressione Ø cm 20,
Coperchio in vetro
Ø cm 20.

*18/0 stainless steel pot Ø
20 cm 5L capacity, 18/0
stainless steel pot Ø 20 cm
7L capacity, 18/0 pressure
cooker Ø 20 cm lid, Ø 20
cm glass lid.*



RICAMBI / SPARE PARTS

cod. R800500 coperchio completo / lid for pressure cooker

TENDER ALU EASY

Alluminio con rivestimento antiaderente GREBLON COMPOUND professionale a 3 strati, senza PFOA.

Aluminum with GREBLON COMPOUND professional non-stick coating (3 layers), PFOA free.

Manici in tubolare d'acciaio atermico e applicati con rivetti.

Riveted tubular stainless steel handles.



GAS
GAS



CERAMICO
CERAMIC



ALOGENO
HALOGEN



ELETTRICO
ELECTRIC

In esaurimento / Discontinued

Padella bassa con antiaderente / *Non-stick low frying pan*

cod. 350925..

Ø cm	h cm	Lt
20	4,0	1,0
24	4,5	1,6
28	5,2	2,6
32	6,0	4,0
36	6,7	5,7
40	7,5	7,9
45	8,4	11,2



Padella alta con antiaderente / *Non-stick deep frying pan*

cod. 3509C5..

Ø cm	h cm	Lt
20	4,7	1,2
24	5,4	2,0
28	6,3	3,3
32	7,2	5,0
36	8,1	7,1



Padella bassa / *Low frying pan*

cod. 350025..

Ø cm	h cm	Lt
20	4,0	1,0
24	4,5	1,6
28	5,2	2,6
32	6,0	4,0
36	6,7	5,7
40	7,5	7,9
45	8,4	11,2



Padella alta / *Deep frying pan*

cod. 3500C5..

Ø cm	h cm	Lt
20	4,7	1,2
24	5,4	2,0
28	6,3	3,3
32	7,2	5,0
36	8,1	7,1





POP 3790

Alluminio stampato in 2,5 mm con rivestimento antiaderente XYLAN 2 strati.
2,5 mm pressed aluminum with XYLAN 2 layers non-stick coating.

Fondo HOLE INDUCTION.
Bottom: HOLE INDUCTION.

Manici in bakelite atermica.
Handle with "stay-cool" bakelite material.

NICKEL
FREE



INDUZIONE
INDUCTION



GAS
GAS



CERAMICO
CERAMIC



ALOGENO
HALOGEN



ELETTRICO
ELECTRIC

Casseruola alta con coperchio / *Deep casserole with lid*
cod. 3790V1..

Ø cm	h cm	Lt
20	7,7	2,4
24	10,5	4,8



Casseruola 1 manico / *Saucepan*
cod. 37900616

Ø cm	h cm	Lt
16	6,7	1,3



Wok con coperchio / *Wok with lid*
cod. 37909528

Ø cm	h cm	Lt
28	7,67	4,1



Crepiera / *Crepe frying pan*
cod. 37904525

Ø cm	h cm	Lt
25	1,61	0,7



Bistecchiera / *Grill pan*
cod. 37905326

Ø cm	h cm	Lt
26	3,98	2,3



Set 2 padelle
Set 2 frying pans

cod.	Ø cm
37902503	20+24
37902504	24+28



Set 3 padelle
Set 3 frying pans

cod.	Ø cm
37902500	20+24+28



Padella / Frying pan
cod. 379025..

Ø cm	Lt
20	1,1
22	1,3
24	1,8
26	1,9
28	2,8
30	3,0



padella con manico e maniglia / frying pan
with counter handle
cod. 37902532

Ø cm	h cm	Lt
32	5,39	3,9



POP EXTRA 3790

Alluminio stampato in 2 mm con rivestimento antiaderente 2 strati.
2 mm pressed aluminum with 2 layers non-stick coating.

Manico in bakelite atermica.
Handle with "stay-cool" bakelite material.

NICKEL
FREE



GAS
GAS



CERAMICO
CERAMIC



ALOGENO
HALOGEN



ELETTRICO
ELECTRIC

Padella pancake e uova / Egg & pancake frying pan
cod. 37902G25

Ø cm
25



COOK-IT

3190

Alluminio stampato con rivestimento antiaderente 5 strati.
Pressed aluminum with 5 layers non-stick coating.

Made in Italy 

Manico in materiale termoisolante antiscottatura.
Handle with "stay-cool" material.

NICKEL
FREE



GAS
GAS



CERAMICO
CERAMIC



ALOGENO
HALOGEN



ELETTRICO
ELECTRIC

Padella / *Frying pan*
cod. 319025..

Ø cm

20

24

28



Padellino uovo / *Egg frying pan*
cod. 31902514

Ø cm

14



Crepiera / *Crepe frying pan*
cod. 31904525

Ø cm

25



Gira frittata / *Omelette pan*
cod. 31902D26

Ø cm

26



X-BLACK 4180

Alluminio forgiato con rivestimento antiaderente senza PFOA.
Forged aluminum with PFOA-free non-stick coating.

Bordo rinforzato 3,5 mm.
3.5 mm reinforced rim.

Manici in bakelite atermica.
Handle with "stay-cool" bakelite material.

NICKEL
FREE



INDUZIONE
INDUCTION



GAS
GAS



CERAMICO
CERAMIC



ALOGENO
HALOGEN



ELETTRICO
ELECTRIC

Casseruola fonda con coperchio / *Deep casserole with lid*
cod. 4180V1..

Ø cm	Lt
20	2,3
24	4,2
28	6,6



Casseruola fonda / *Deep casserole*
cod. 418005..

Ø cm	Lt
20	2,3
24	4,2
28	6,6



Casseruola 1 manico / *Saucepan*
cod. 41800616

Ø cm	Lt
16	1,2



Wok con coperchio / *Wok with lid*
cod. 41809528

Ø cm	Lt
28	3,5



Wok / *Wok*
cod. 41809S28

Ø cm	Lt
28	3,5



Crepiera / Crepe frying pan
cod. 41804525

Ø cm	Lt
25	0,5



Bistecchiera / Grill pan
cod. 41805328

Ø cm	Lt
26	2,2



Set 2 padelle / Set 2 frying pans
cod. 41802504

Ø cm
24+28



Padella / Frying pan
cod. 418025..

Ø cm	Lt
20	1,0
24	1,6
26	2,0
28	2,4
30	3,3



Coperchio / Lid
cod. 40403A..

Ø cm
20
22
24
26
28



SMART 4240

Alluminio stampato con rivestimento antiaderente senza PFOA.
Stamped aluminum with PFOA-free non-stick coating.

Manico in bakelite atermica.
Handle with "stay-cool" bakelite material.

NICKEL
FREE



INDUZIONE
INDUCTION



GAS
GAS



CERAMICO
CERAMIC



ALOGENO
HALOGEN



ELETTRICO
ELECTRIC

Set 2 padelle / *frying pans set*
cod. 42402501

Ø cm

24+28



PORTOFINO

305_

Alluminio con rivestimento antiaderente 5 strati, senza PFOA.
Aluminum with 5-layer non-stick coating PFOA free.

Made in Italy 

Manico in materiale antiscottatura.
Handle with thermosetting material.

NICKEL
FREE



GAS
GAS



CERAMICO
CERAMIC





ALOGENO
HALOGEN



ELETTRICO
ELECTRIC

Padella / Frying pan

cod.	Ø cm	colour
305B2520	20	
305B2524	24	ROSA
305B2528	28	TRAMONTO
305C2520	20	
305C2524	24	BLU MARE
305C2528	28	BLU MARE
305A2520	20	
305A2524	24	VERDE BASILICO
305A2528	28	VERDE BASILICO



GASTRONORM

GN-P

RBA_

Gastronorm in acciaio inox 18/10.
18/10 stainless steel gastronorm.

Bacinella 1/1 Basin 1/1

cod.	OUT mm	h mm	Lt	Master	cm Master	kg Master
RBA11020	530x325	20	tray	5	35x55x10	5,25
RBA11040		40	5,4		35x55x10	5,15
RBA11065		65	8,7		35x55x10	7,58
RBA11100		100	13,0		35x55x20	7,99
RBA11150		150	20,0		35x55x30	10,40
RBA11200		200	26,0		35x55x34	11,42

Bacinella 1/2 Basin 1/2

cod.	OUT mm	h mm	Lt	Master	cm Master	kg Master
RBA12020	325x265	20	tray	10	34x38x10	4,60
RBA12040		40	2,4	10	34x38x10	5,13
RBA12065		65	3,8	10	35x55x10	5,97
RBA12100		100	5,9	10	35x55x20	9,37
RBA12150		150	8,7	5	34x38x20	6,07
RBA12200		200	11,0	5	35x55x25	5,88

Bacinella 1/3 Basin 1/3

cod.	OUT mm	h mm	Lt	Master	cm Master	kg Master
RBA13065	325x176	65	2,5	10	35x55x10	5,76
RBA13100		100	3,8		34x38x20	6,49
RBA13150		150	5,5		34x38x20	6,49
RBA13200		200	7,0		35x55x20	9,15

Bacinella 1/4 Basin 1/4

cod.	OUT mm	h mm	Lt	Master	cm Master	kg Master
RBA14020	265x162	20	tray	10	17x27x10	2,62
RBA14040		40	1,2	10	17x27x10	3,72
RBA14065		65	1,7	10	17x27x20	3,78
RBA14100		100	2,7	20	35x55x20	10,20
RBA14150		150	3,8	10	35x55x20	5,17
RBA14200		200	4,8	10	35x55x30	9,34

Bacinella 1/6
Basin 1/6

cod.	OUT mm	h mm	Lt	Master	cm Master	kg Master
RBA16065	176x162	65	1,0	20	17x27x20	5,00
RBA16100		100	1,6		35x55x20	6,61
RBA16150		150	2,2		34x38x20	8,34
RBA16200		200	2,8		35x55x20	10,66

Bacinella 1/9
Basin 1/9

cod.	OUT mm	h mm	Lt	Master	cm Master	kg Master
RBA19065	176x108	65	0,6	30	34x38x20	7,47
RBA19100		100	0,9		34x38x20	8,51

Bacinella 2/1
Basin 2/1

cod.	OUT mm	h mm	Lt	Master	cm Master	kg Master
RBA21020	650x530	20	tray	5	56x67x10	11,88
RBA21040		40	12,0		56x67x10	11,75
RBA21065		65	19,0		56x67x10	13,76
RBA21100		100	29,0		56x67x20	15,25
RBA21150		150	43,0		56x67x27	18,34
RBA21200		200	57,0		56x67x27	21,13

Bacinella 2/3
Basin 2/3

cod.	OUT mm	h mm	Lt	Master	cm Master	kg Master
RBA23020	354x325	20	tray	10	34x38x10	5,86
RBA23040		40	3,4		34x38x10	8,40
RBA23065		65	5,5		34x38x20	10,37
RBA23100		100	8,4		34x38x30	12,89
RBA23150		150	12,0		34x38x35	14,00
RBA23200		200	16,0		34x38x35	14,04

Coperchio bacinella
Basin lid

cod.	Mod.	OUT mm	h mm	Lt	Master	cm Master	kg Master
RCO11000	1/1	530x325	-	-	10	35x55x20	10,86
RCO12000	1/2	325x265	-	-	10	34x28x20	5,38
RCO13000	1/3	325x176	-	-	10	34x28x10	3,52
RCO14000	1/4	265x162	-	-	10	17x27x20	2,60
RCO16000	1/6	176x162	-	-	20	34x28x10	3,64
RCO19000	1/9	176x108	-	-	20	17x27x20	2,51
RCO23000	2/3	354x325	-	-	10	34x38x20	7,98

MULTIPLI: LE COMBINAZIONI

Multiples: the combinations

2/1



1/1



2/3

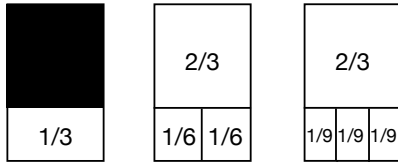

1/2

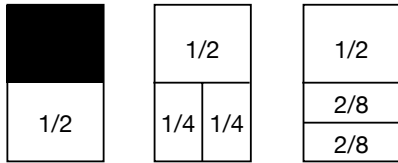

2/4

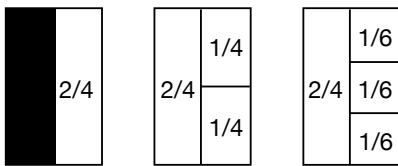

1/3

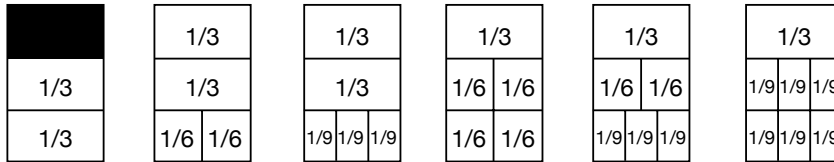

1/4

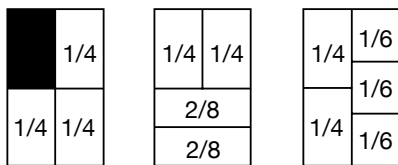

2/8

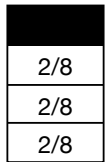

1/6

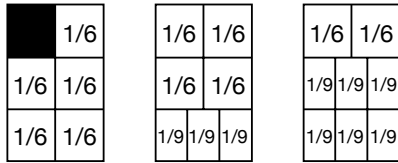

1/9

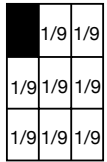

UTENSILI DA CUCINA
KITCHEN TOOLS

GADGET FAST

7820

Acciaio inox con manico in polipropilene ergonomico.
Stainless steel with ergonomic handle in polipropilene.

Design bicolore e packaging dedicato per ogni articolo.
Two-tones design and dedicated packaging for each item.

Spremi aglio / *Garlic press*
cod. 78200001



Apribottiglia / *Bottle opener*
cod. 78200002



Scavino melone / *Melon baller*
cod. 78200003



Pelapatate / *Peeler*
cod. 78200004



Pelapatate multiuso
con lama liscia / *Peeler plain*
cod. 78200005



Pelapatate multiuso con lama
seghettata / *Peeler serrated*
78200006



Dosatore gelato / *Ice-cream scoop*
cod. 78200007



Coltello burro / *Butter knife*
cod. 78200008



Riga limoni / *Lemon zester*
cod. 78200009



Rotella taglia pizza / *Pizza cutter*
Ø cm 10
cod. 78200010



Rotella taglia pizza / *Pizza cutter*
Ø cm 6,5
cod. 78200011



Rotella seghettata / *Pastry wheel serrated*
Ø cm 5,5
cod. 78200012



Rotella doppia / *Pastry wheel double*
cod. 78200013

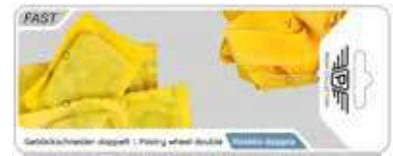

Scava zucchine / *Zucchini corer*
cod. 78200014



Affilacoltelli / *Knife sharpener*
cod. 78200015



Leva torsolo / *Apple corer*
cod. 78200016



Tagliaverdure / *Vegetable cutter*
cod. 78200017



Grattugia lama fina / *Fine grater*
cod. 78200018



Grattugia lama grossa / *Coarse grater*
cod. 78200019



Pala taglia formaggi / *Cheese slicer*
cod. 78200020



Pala torta / *Cake server*
cod. 78200021



Pala pizza seghettata / *Pizza-pie server*
cod. 78200022





GADGET FPR

782F

Acciaio inox con manico in polipropilene ergonomico.
Design bicolore e packaging dedicato per ogni articolo.

Stainless steel with ergonomic handle in polipropilene.
Two-tones design and dedicated packaging for each item.

Apribottiglia / *Bottle opener*
cod. 782F0002



Scavino melone / *Melon baller*
cod. 782F0003



Pelapatate / *Peeler*
cod. 782F0004



Pelapatate ad arco / *Y-peeler*
782F0025



Dosatore gelato / *Ice-cream scoop*
cod. 782F0007



Spatola / *Turner*
cod. 782F0022



Pennello in silicone / *Silicone brush*
cod. 782F0023



Rotella taglia pizza / *Pizza cutter*
Ø cm 6,6
cod. 782F0011



Leva torsolo / *Apple corer*
cod. 782F0016



Grattugia / *Grater*
cod. 782F0024



Apriscatole / *Can opener*
cod. 782F0026



Mestolo salsa / *Sauce ladle*
cod. 782F0029



Pala fritto / *Spatula*
cod. 782F0030



Cucchiaione / *Serving spoon*
cod. 782F0031



Servispaghetti / *Spaghetti server*
cod. 782F0032



Forchettone / *Carving fork*
cod. 782F0033



Mestolo / *Ladle*
cod. 782F0028



Frusta / *Whisk*
cod. 782F0034



Schiumarola / *Skimmer*
cod. 782F0027



Colino / *Strainer*
cod. 782F0035



Schiaccianoci / *Nutcracker*
cod. 782F0036



Cavatappi due leve / *Corkscrew winged*
cod. 587F4100



Cavatappi professionale / *Professional corkscrew*
cod. 587F4300



Batticarne / *Meat mallet*
cod. 782F0037



Apribarattoli / *Jar opener*
cod. 782F0038



Frullino / *Manual whisk*
cod. 782F0039



Frusta in silicone / *Silicone whisk*
cod. 782F0040



Frangi fiamma / *Heat diffuser*
cod. 782F0041



Para spruzzi / *Splash guard*
cod. 782F0043



SMART

5217

Nylon PA66 - Max 210°C

Consigliati per padelle antiaderenti.
Recommended for non-stick frying pans.

Cucchiaio / *Serving spoon*
cod. 52170000



Cucchiaio forato / *Perforated spoon*
cod. 52170100



Mestolo / *Ladle*
cod. 52172000



Schiumarola / *Skimmer*
cod. 52174000



Servispaghetti / *Spaghetti server*
cod. 52177000



Spatola / *Spatula*
cod. 52176000



Spatola forata / *Perforated spatula*
cod. 52173000



Frusta / *Whisk*
cod. 52171800



Pinza / *Chef tong*
cod. 52179100





PINTI INOX S.p.A.
Via Antonini, 87
25068 Sarezzo (BS) Italia
Tel. +39 030 89351
Fax +39 030 8935250
+39 030 8901163
www.pintinox.com
pintinox@pinti.it

PINTI INOX GMBH
DEUTSCHLAND
Römerstraße 91
73066 Uhingen
Tel +49 07161 93343-0
Fax +49 07161 352789
www.pinti.de
info@pinti.de